

CHALLENGE CARDS

44 engineering and science challenges
from the engineers at Dyson.



Please note that the activities contained here in are intended for children
ages seven and above. Adult supervision is recommended for all projects.

HOW MANY CAN YOU COMPLETE?

Tick the box once you've completed the challenge.

SCIENCE CHALLENGES		01 CHANGING STATES	02 UNDERWATER VOLCANO	03 FLOATING PING-PONG BALLS	04 BALLOON KEBABS
05 LIQUID DENSITIES	06 EXPANDING GASES	07 TORNADO IN A BOTTLE	08 NON-NEWTONIAN FLUID	09 BRIGHT AS A NEW PENNY	10 LENZ'S LAW
11 INERTIAL EGGS	12 $100 + 100 = 192?$	13 MEASURE THE SPEED OF LIGHT	14 WEATHER BALLOON	15 FLOATING PAPER CLIP	16 FIRE EXTINGUISHER
17 SCARED PEPPER	18 DANCING RAISINS	19 HOW TO MAKE A LAVA LAMP	20 IVORY SOAP	21 COLOURED CARNATIONS	22 INVISIBLE INK
ENGINEERING CHALLENGES		01 GEODESIC DOMES	02 MARBLE RUN	03 SPAGHETTI BRIDGES	04 STRONG AS A DRINKING STRAW
05 ELECTRIC MOTOR	06 COTTON REEL TANK	07 CARDBOARD BOAT	08 CARDBOARD CHAIR	09 BOAT POWERED BY A CHEMICAL REACTION	10 CARTESIAN DIVER
11 BALLOON CAR RACE	12 DESIGN AND BUILD A HELICOPTER	13 WATER CLOCK	14 METAL ETCHING	15 JELLY AND OIL	16 BUILD A COMPASS
17 A TOUGH NUT TO CRACK	18 BURNING CUSTARD	19 HOMEMADE WATER BOMB	20 POTATO POWER	21 MAKE A PERISCOPE	22 ATTRACTIVE NAILS

CHANGING STATES

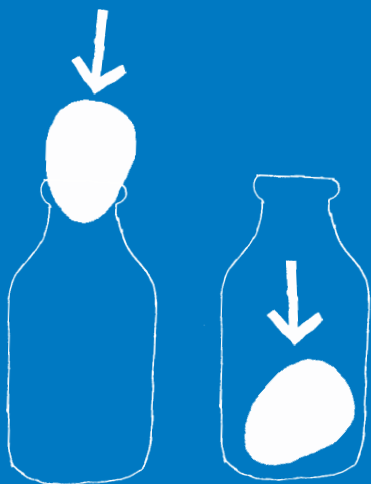

CHANGING STATES

Designed by Charles,
Design engineer at Dyson

The brief

Make an egg fit into a bottle without breaking it.

The method

1. Submerge the egg in a glass of vinegar for two days: the shell will become rubbery.
2. Heat the bottle in hot water – remember to use gloves or a tea towel when handling it.
3. Rest the egg on the neck of the bottle.
4. As the air inside the bottle cools down, it will contract and suck the egg down.

Top tip

Try lubricating the egg with cooking oil or washing up liquid.

Materials

- An uncooked egg
- A pan of boiling water (with adult supervision)
- A glass of vinegar
- A wide-mouthed glass bottle

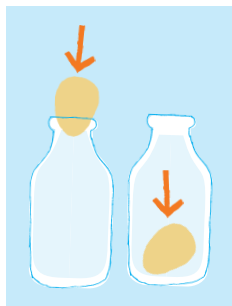

How does it work?

Eggs are rich in protein. When heat is applied, chemical bonds within the protein molecules are broken, and new bonds are formed between adjacent molecules. This creates a network of inter-connected proteins which causes the egg to go hard.

Vinegar contains acetic acid (CH_3COOH) that dissolves the calcium carbonate (CaCO_3) shell but leaves behind the egg's springy membrane.

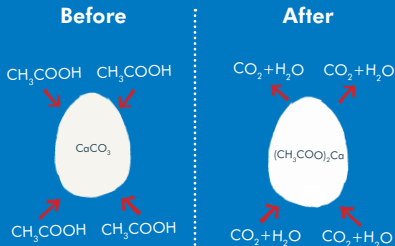

SCIENCE
CHALLENGE

02

UNDERWATER VOLCANO



THE
JAMES
DYSON
FOUNDATION

UNDERWATER VOLCANO

SCIENCE
CHALLENGE

02

Designed by Ian,
Design engineer at Dyson

The brief

Create a colourful underwater volcano.

The method

1. Cut a two foot length of string with a pair of scissors. Tie a knot around the neck of a salt shaker with one end of the string. Double-knot it to ensure the knot is secure. Repeat this process with the other end of the string, resulting in a handle to lower your shaker.
2. Empty and clean a large jar. Fill the clean jar about three quarters full with cold water.
3. Fill the salt shaker with hot water (with adult supervision) – as hot as you can get from your tap – to just below the neck. Add three to four drops of red food colouring.
4. Hold your salt shaker over the mouth of the jar by the string handle. Slowly lower the salt shaker into the jar until the shaker is completely submerged and resting upright on the bottom of the jar. Observe how the coloured water erupts from the shaker into the cold water.

Materials

String

Scissors

(with adult supervision)

An empty salt shaker

A large jar

Food colouring



How does it work?

This shows how convection currents work. A convection current is the way that heat rises and falls in liquids and gases.

Design icons

Hot air balloons use convection currents. As hot air rises, so too does the balloon.



SCIENCE
CHALLENGE

03

FLOATING PING-PONG BALLS



THE
JAMES
DYSON
FOUNDATION

FLOATING PING-PONG BALLS

The brief

Make two ping-pong balls float in the air flow of a hair dryer at the same time, without hitting each other.

The method

1. Switch on your hairdryer, making sure it is on the cool setting.
2. Hold it with the nozzle pointing upwards.
3. Place one of the ping-pong balls into the stream of air.
4. Try and place another ball into the same stream of air – on top of the first ball.

Materials

Two ping-pong balls

A hairdryer
(on cool setting)

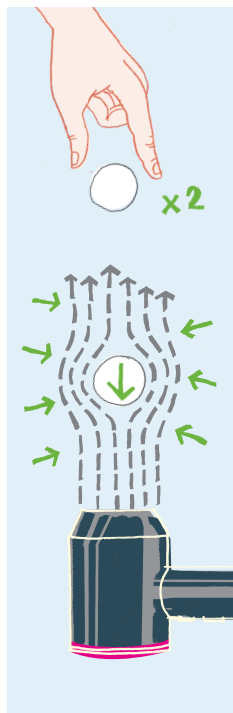

How does it work?

The hair dryer produces a high velocity stream of air with low pressure. The surrounding air is at a higher pressure which keeps the ball inside the stream. When the upward force of the air equals the weight of the ping-pong ball the ball is said to be in 'equilibrium'.

The theory at work here is Bernoulli's principle. This is an equation linking air pressure, velocity and density with particle weight.

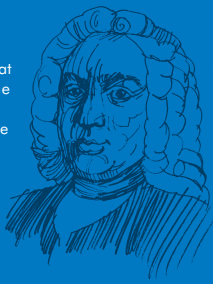

SCIENCE
CHALLENGE

04

BALLOON KEBABS



THE
JAMES
DYSON
FOUNDATION

BALLOON KEBABS

SCIENCE
CHALLENGE

04

Designed by Phil,
Design engineer at Dyson

The brief

Push a wooden skewer through a balloon without popping it, creating a “balloon kebab”.

The method

1. Dip the skewer in the cooking oil.
2. Push the skewer into the balloon until it pierces the skin.
3. If the balloon bursts, try again – look for the places where the rubber is least stretched.

Materials

.....
A balloon inflated
until $\frac{3}{4}$ full

.....
A wooden skewer

.....
Cooking oil

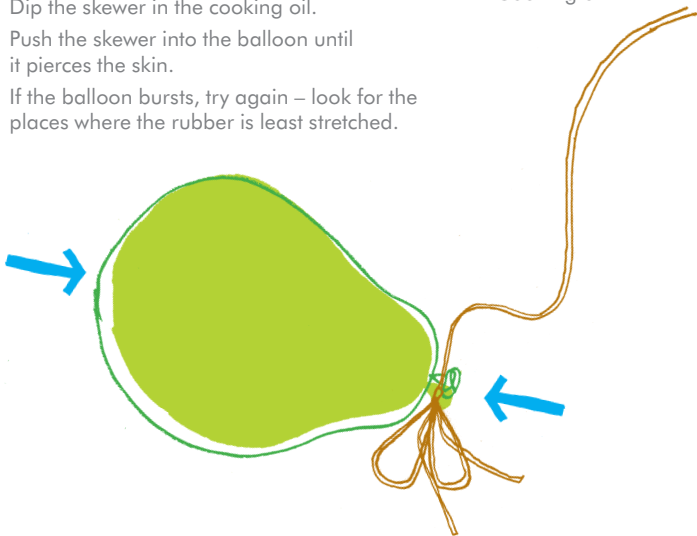

How does it work?

Most of the balloon is stretched evenly, but there are two points where the rubber is least stretched. The tied section and the darker patch at the opposite side of the balloon have the lowest surface tension. Most of the balloon is under high tension, so attempting to push the skewer through just makes the balloon pop. At the low tension sections it is possible to make a small hole without breaking the overall surface of the balloon.

LIQUID DENSITIES

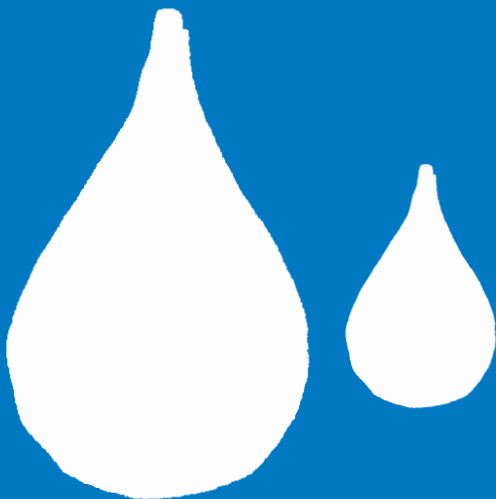

LIQUID DENSITIES

Designed by Ben,
Design engineer at Dyson

The brief

Layer different liquids in a tube and discover how and why they settle in a certain order.

The method

1. Start by adding food colouring to the surgical spirit and to the water – using a different shade for each. This will allow you to identify each liquid.
2. Measure out equal quantities of each liquid. Add them to the tube, one by one.

Top tip

Try weighing each liquid before you add it and predict which order the liquids will settle in. The layers may be a little mixed at first. Allow them to settle for a moment and watch the layers start to define.

How does it work?

Different liquids have different densities and therefore, different weights. The heaviest liquids will sink, the lighter liquids will rise to the top. Density is a comparison between an object's mass and volume. Remember the equation:

$$\text{DENSITY} = \frac{\text{MASS}}{\text{VOLUME}}$$

Based on this, if the weight – or mass – of something increases but the volume stays the same, the density has to go up. Lighter liquids, like water, are less dense than heavy liquids, like honey, and so float on top of the more dense layers.

Materials

A test tube
Honey
Oil
Surgical spirit
Water
Washing up liquid
Two shades
of food colouring

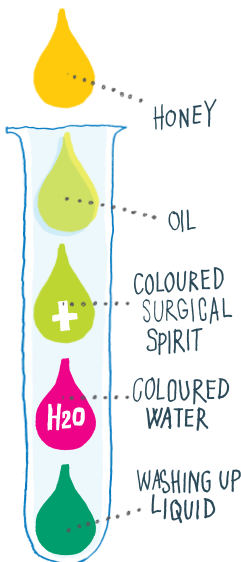

EXPANDING GASES



EXPANDING GASES

SCIENCE
CHALLENGE

06

Designed by David,
Senior mechanical engineer
at Dyson

The brief

Find out what happens when gases are heated up or cooled down.

The method

1. Fill two bowls – one with cold water the other with hot water.
2. Put the bottle into cold water.
3. Fit a balloon to the neck of the bottle.
4. Now place the bottle into the hot water.
5. Watch the balloon expand.

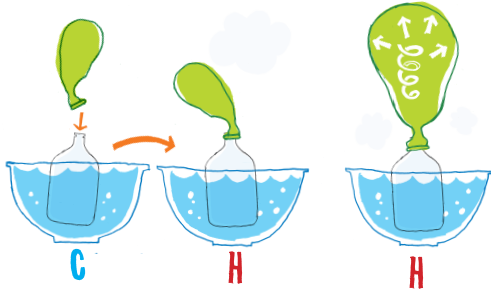

Materials

Two bowls

Cold water, hot water
(with adult supervision)

A sturdy plastic bottle

A balloon

How does it work?

Gas expands when it is heated. The rule is, if the pressure of a gas remains constant, the volume of the gas will increase as the temperature increases. So if the temperature increases, the gas takes up more space. This is known as Charles' Law. The principle was first formulated by the French physicist Jacques Alexandre Cesar Charles in 1787.

Design icons

Steam engines heat up air and allow it to expand in cylinders to drive wheels.

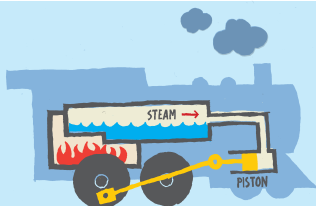

TORNADO IN A BOTTLE



TORNADO IN A BOTTLE

SCIENCE
CHALLENGE

07

Designed by Adam,
Design engineer at Dyson

The brief

Create a water vortex in a bottle.

The method

1. Fill the plastic bottle with water until it reaches around three quarters full.
2. Add a few drops of washing up liquid.
3. Sprinkle in a few pinches of glitter (this will make your tornado easier to see).
4. Put the cap on tightly.
5. Turn the bottle upside down and hold it by the neck. Quickly spin the bottle in a circular motion for a few seconds. Stop and look inside to see if you can see a mini tornado forming in the water. You might need to try it a few times before you get it working properly.

Materials

Water

A clear plastic bottle

Glitter

Washing up liquid

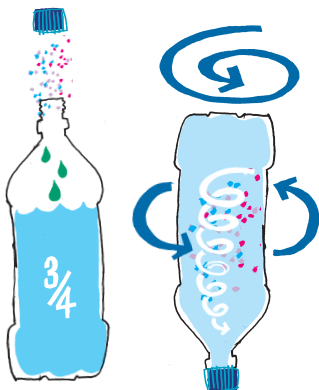

How does it work?

The water is rapidly spinning around the centre of the vortex due to centripetal force. This is an inward force directing an object or fluid such as water towards the centre of its circular path.

Did you know?

Vortices found in nature include tornadoes, hurricanes and waterspouts.



NON- NEWTONIAN FLUID



NON- NEWTONIAN FLUID

Designed by Rory,
Design engineer at Dyson

The brief

Create a liquid that turns into a solid when tapped.

The method

1. Add the corn starch to the bowl.
2. Add water slowly to the mixture, stirring in one tablespoon at a time, until all of the powder is wet.
3. Continue to add water until the corn starch acts like a liquid when you stir it slowly – but when you tap it with your finger it becomes hard.
4. Scoop the mixture into your hand and slowly work it into a ball.
5. As long as you keep pressure on it by rubbing it between your hands, it stays solid. Stop rubbing, and it melts into a puddle in your palm.

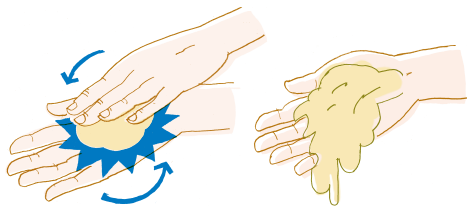

Materials

60g corn starch

60ml water

A spoon

A bowl for mixing

Design icons



Sir Isaac Newton described how 'normal' liquids or fluids behave. He observed that their viscosity only changes with variations in temperature or pressure. In non-Newtonian fluids their viscosity also depends on the force applied to the liquid.

How does it work?

When you mix cornflour with water, the large cornflour particles remain suspended in the liquid. When you stir the mixture slowly it acts like a liquid because the suspended particles have time to move past each other. When you put sudden stress on the mixture, the water quickly flows out of the area but the particles do not have enough time to move out of the way – making the mixture act like a solid.

SCIENCE
CHALLENGE

09

BRIGHT AS A NEW PENNY

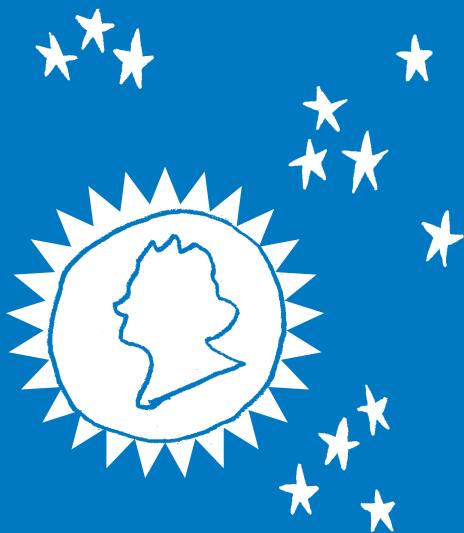

THE
JAMES
DYSON
FOUNDATION

BRIGHT AS A NEW PENNY

SCIENCE
CHALLENGE

09

Designed by Roy,
Design engineer at Dyson

The brief

Clean a penny using cola.

The method

1. Place the penny in the container.
2. Add enough cola so the penny is covered.
3. Leave overnight.
4. In the morning, you should find that your penny is clean.

Materials

Shallow container

Cola

A penny – the older and dirtier the better

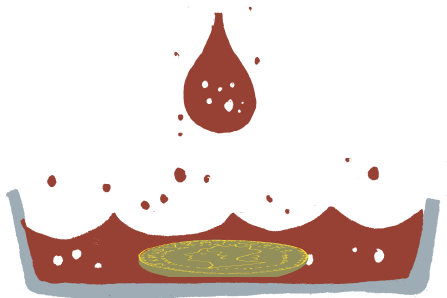

How does it work?

Pennies have a copper coating. As the copper gets older, it reacts with the oxygen in the air and begins to form a copper-oxygen compound. This compound is what makes the penny look dull.

Meanwhile, cola contains phosphoric acid. This acid breaks down the copper-oxygen compound chemical bonds allowing a fresh, unoxidized layer of copper to be exposed.

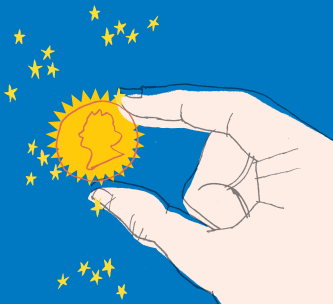

LENZ'S LAW

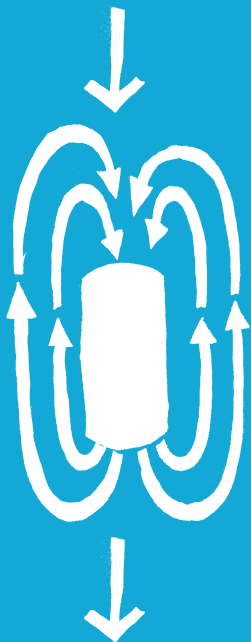

LENZ'S LAW

The brief

Create a working demonstration of Lenz's law.

The method

1. Drop the magnet into the tube.
2. Watch what happens.

Materials

A 30cm long domestic copper plumbing tube
Strong magnet that fits freely – but closely into the tube

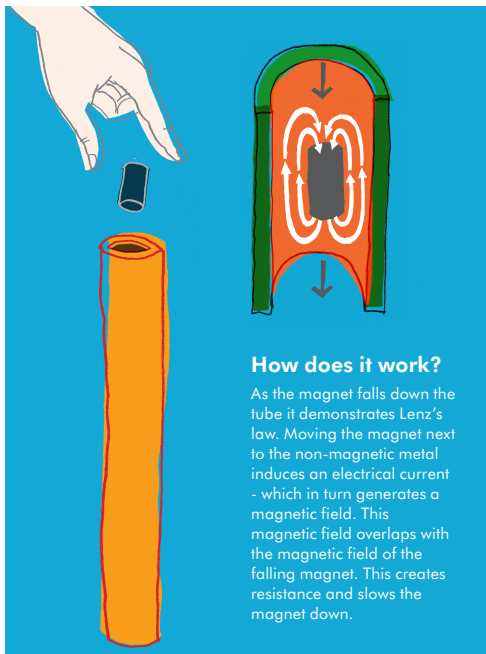

Design icons



This system is similar to how electromagnetic brakes work on rollercoasters. The wheel is the tube, and the magnet is attached to the chassis of the train. The movement of the train is slowed without any friction parts to wear out.

INERTIAL EGGS

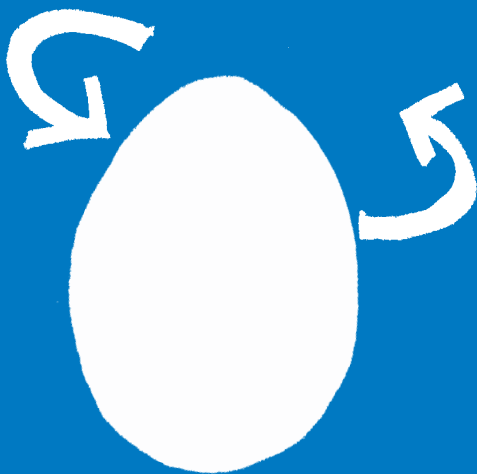

INERTIAL EGGS

Designed by Tom,
Design engineer at Dyson

The brief

Use eggs to find out about momentum and changing direction.

The method

1. Spin each egg, one hard boiled and one fresh, on a table.
2. Leave it to spin for a few seconds then momentarily stop it by placing your finger on top.
3. Release the egg and observe what happens next.

Materials

One hardboiled egg

One fresh egg –
the fresher the better

How does it work?

The fresh egg will start to spin again when the finger is released, while the other will remain at a dead stop. The fresh egg has egg fluid and yolk inside it which gains momentum.

When the egg is momentarily stopped, the yolk continues to turn inside the shell. When it is released, the viscosity of the fluid between the still spinning yolk and the shell causes the shell to spin again.

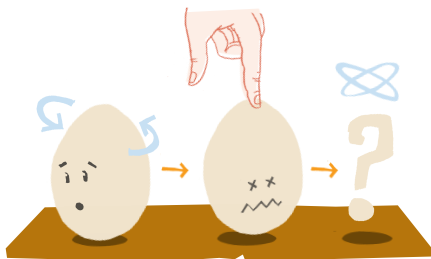

Design icons

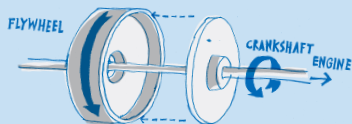

Inertia is the tendency of a moving object to remain moving or a stopped object to remain stopped. In engineering, flywheels are big, heavy wheels that are spun to gain inertia. The energy is stored and released to smooth out the operation of engines that have a short burst of power during their running cycle.

SCIENCE
CHALLENGE

12

$100+100=192?$

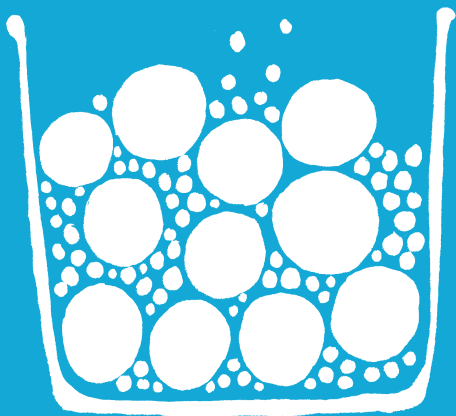

THE
JAMES
DYSON
FOUNDATION

Designed by Chloe,
Research engineer at Dyson

The brief

Add water to ethanol and find out why it doesn't add up.

The method

1. Measure out exactly 100ml of water and 100ml of ethanol.
2. Add the two solutions together in the large measuring cylinder and look at the measurements.
3. You would expect the resulting solution to measure exactly 200ml, however it should actually give a volume of around 192ml.

Top tip

When measuring the liquids, practice your lab skills and get down to eye level to measure to the meniscus. Make sure you get every last drop, and monitor your mixture to see if any gas is given off.

Materials

- 100ml of water
- 100ml of ethanol
(with adult supervision)
- Three measuring cylinders – two smaller to measure out the liquids, and one larger to mix and read off the resulting volume.

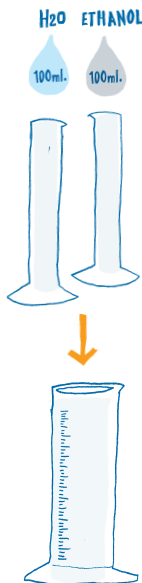

How does it work?

When mixed together, the combined molecules fit together better than when they are alone, so they take up less space. It's similar to what happens when you mix a litre of sand and a litre of rocks.

What's more, the OH⁻ component of the ethanol and the H⁺ of the water molecules are attracted to each other - creating hydrogen bonds. These bonds create a tight molecular formation, reducing the volume of the combined liquids.

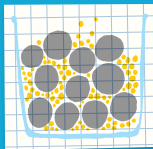

SCIENCE
CHALLENGE

13

MEASURE THE SPEED OF LIGHT

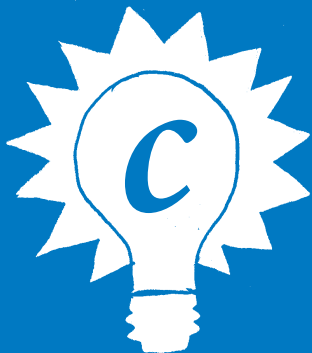

THE
JAMES
DYSON
FOUNDATION

MEASURE THE SPEED OF LIGHT

Designed by Joe,
Design engineer at Dyson

The brief

Measure the speed of light using chocolate and a microwave oven.

The method

1. Remove the glass plate in the base of the microwave and replace with an upturned ceramic plate. You want your chocolate to stay still in this experiment.
2. Place the chocolate in the middle of the plate.
3. Turn on the microwave and heat the chocolate until it melts in 2 or 3 places. This should take about 20 seconds.
4. Using gloves, and with adult supervision, carefully remove the plate from the microwave.

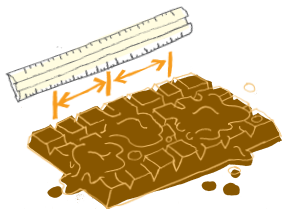

5. Measure the distance, in metres, between the melted spots on the chocolate bar.
6. The distance you measured is half a wavelength. Multiply this number by two and then by the frequency of the microwave you are using. This can be found on the outside of the machine. This number is the speed of light in metres per second.

Materials

- A large bar of chocolate
- A microwave (with adult supervision)
- A large ceramic plate
- A ruler

How does it work?

Microwaves work by creating standing waves inside the microwave oven. The water molecules in the chocolate try to align themselves with the rapidly changing standing wave, creating heat. The distance between the two melted spots is half a wavelength. You can now calculate the speed of light, because $\text{speed} = \text{wave length} \times \text{frequency}$.

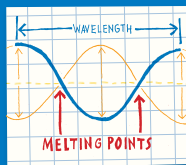

WEATHER BALLOON

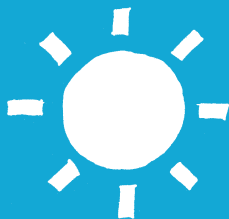

WEATHER BALLOON

Designed by Chris,
Design engineer at Dyson

The brief

Make a barometer and predict the weather.

The method

1. Cut the bottom half off the balloon.
2. Pull the top half of the balloon tight over the jam jar.
3. Use the elastic band to keep the balloon tight over the jar.
4. Fix the straw to the centre of the balloon skin using a piece of sticky tape.
5. Place the paper so that it is lined up against the straw. Draw a line at this position.
6. Above the line write the word "high" and below the line write "low".
7. Note down the pressures each day to see if you can notice a pattern between your air pressure readings and the weather outside.

Materials

- A glass jar
- A balloon
- A rubber band
- Scissors
- (with adult supervision)
- A straw
- Sticky tape
- Some paper
- A pen

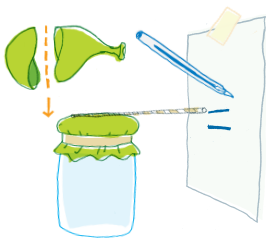

How does it work?

As the air is sealed inside the jar, any changes to the air pressure outside the jar will result in direct movement of the balloon rubber. As the outside air pressure increases, the rubber will be forced down into the jar. The straw pivoting on the glass will rise upward. The opposite is true when the pressure decreases.

Design icons

Barometers are used by weather forecasters to help predict the weather.

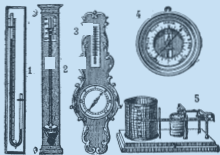

SCIENCE
CHALLENGE

15

FLOATING PAPER CLIP



THE
JAMES
DYSON
FOUNDATION

FLOATING PAPER CLIP

Designed by Nor,
Test engineer at Dyson

The brief

Make a paper clip float on water.

The method

1. Fill the bowl with water.
2. Tear off some tissue paper (around 10cm x 5cm).
3. Gently place the tissue paper onto the surface of the water so that it floats.
4. Place the dry paper clip on top of the tissue.
5. Use the rubber end of the pencil to carefully poke until the tissue sinks and the paperclip is left floating.

Materials

Water

A bowl

Tissue paper

A paper clip

A pencil with a
rubber on the end

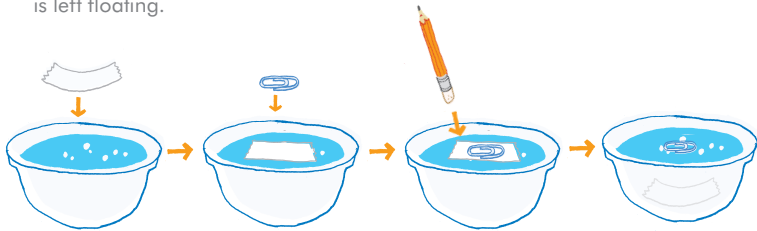

How does it work?

The paper clip is held afloat by the surface tension of the water. Water molecules are polar, so the molecules pull on each other. This creates a tension – like a thin, flexible membrane on the surface – which helps hold the needle afloat. The tissue paper allows you to lower the paperclip onto the water gently, without breaking the surface tension.

Did you know?

Insects such as pond skaters use water tension to appear to walk on water.

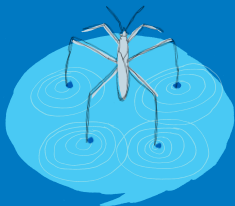

SCIENCE
CHALLENGE

16

FIRE EXTINGUISHER



THE
JAMES
DYSON
FOUNDATION

SCIENCE
CHALLENGE

17

SCARED PEPPER



THE
JAMES
DYSON
FOUNDATION

FIRE EXTINGUISHER

Designed by Liam,
Design engineer at Dyson

The brief

Create your own invisible fire extinguisher.

The method

1. With the help of an adult, light the candle.
2. Mix a little bicarbonate of soda and vinegar together in the jar to make a frothing mixture.
3. Tip the jar over the candle so only the gas from the reaction comes out. Be careful not to tip the mixture out.
4. The flame will be extinguished.



Materials

Matches

(with adult supervision)

Bicarbonate of soda

Vinegar

Candle

A jam jar

Design icons

Dry chemical extinguishers are filled with powder, which is usually sodium bicarbonate or baking soda. When released over the fire, the powder decomposes at 70°C releasing CO₂, smothering the fire.



How does it work?

The mixture of bicarbonate of soda and vinegar creates carbon dioxide. CO₂ is heavier than air so it sits at the bottom of the glass. When you tip up the glass, the CO₂ comes out and suffocates the candle.

SCARED PEPPER



SCARED PEPPER

Designed by Robyn,
James Dyson
Foundation executive

The brief

Move pepper away from you without touching it.

The method

1. Fill the bowl with water.
2. Add some pepper to the top of the water, do not stir it in.
3. Dip your finger into the water, note down what happens.
4. Put a small amount of soap on your finger.
5. Dip it back into the water.
6. What happens to the pepper?

Materials

Ground black pepper

A bowl

Water and washing up liquid or soap

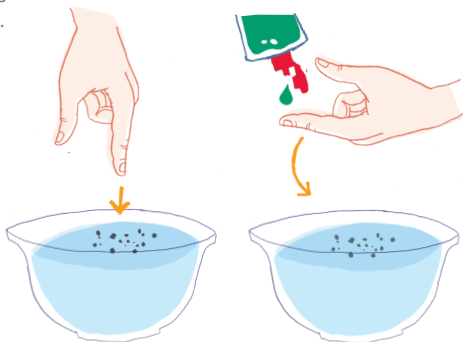

How does it work?

Water normally bulges up a bit. You can see this by looking at a raindrop or by filling a glass slightly over the rim – the water will not spill out. When soap is added to water, surface tension is lowered. The water tries to spread out. As the top of the water flattens out, the pepper on the surface is carried to the edge of the bowl.

Did you know?

In the cosmetics industry the surface friction and consistency of various liquids are regularly changed in order to make them easier to pour or spray.

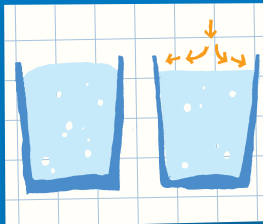

DANCING RAISINS



DANCING RAISINS

Designed by Danya,
James Dyson
Foundation executive

The brief

Make raisins dance up and down in a glass of fizzy drink.

The method

1. Pour the can of drink into the tall glass.
2. Notice the bubbles coming up from the bottom of the glass. The bubbles are carbon dioxide gas released from the liquid.
3. Drop a few raisins into the glass. Watch the raisins for a few seconds. Describe what is happening to the raisins.
4. Do they sink or float? Keep watching, what happens?

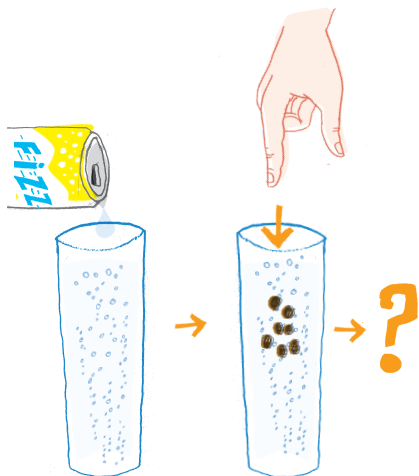

Materials

- A can of clear, fizzy drink (e.g. lemonade)
- A tall, clear glass
- A handful of raisins

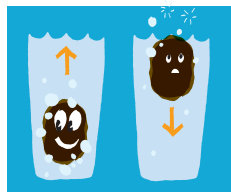

How does it work?

Raisins have a higher density than the liquid in the glass, so they sink to the bottom. Carbon dioxide bubbles attach themselves to the raisins increasing their volume while adding very little to their mass. With greater volume, the raisin displaces more fluid. This causes the water to exert greater buoyant force, pushing the raisins upwards. Once the raisins reach the top of the glass the carbon dioxide escapes and the raisins sink again.

SCIENCE
CHALLENGE

19

HOW TO MAKE A LAVA LAMP



THE
JAMES
DYSON
FOUNDATION

HOW TO MAKE A LAVA LAMP

Designed by Gemma,
James Dyson
Foundation executive

The brief

Make your own lava lamp.

The method

1. Fill the empty bottle $\frac{3}{4}$ full with vegetable oil.
2. Top it off with water and about 10 drops of food colouring.
3. Break an Alka-Seltzer® tablet into pieces, and add pieces of the tablet to the bottle. The mixture will bubble.
4. Put the cap on and gently tip the bottle back and forth. This will cause the tiny droplets of coloured water moving around inside the oil to join together, making bigger blobs. Do not shake the bottle.
5. Shine a torch into the bottle from underneath, illuminating the bubbles.

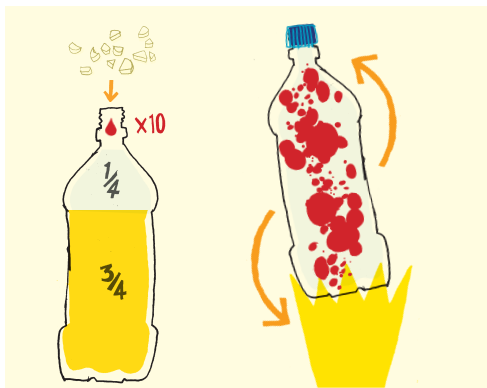

Materials

Empty water bottle

A large bottle of
vegetable oil

Food colouring

Alka-Seltzer® tablets
(with adult supervision)

Water

A torch



How does it work?

Oil is hydrophobic – it will not mix with water – even if you try to really shake the bottle. The Alka-Seltzer® tablet reacts with the water to make tiny bubbles of carbon dioxide which are lighter than water. They attach themselves to the blobs of coloured water, causing them to float to the surface. When the bubbles pop, the coloured blobs sink back to the bottom of the bottle.

SCIENCE
CHALLENGE

20

IVORY SOAP



THE
JAMES
DYSON
FOUNDATION

IVORY SOAP

SCIENCE
CHALLENGE

20

Designed by Lydia,
Global head of the
James Dyson Foundation

The brief

Create a big soapy marshmallow out of Ivory soap®.

The method

1. Place the bar of soap in the middle of a plate covered with a paper towel and place in the centre of the microwave oven.
2. Cook the bar of soap on high for two minutes.

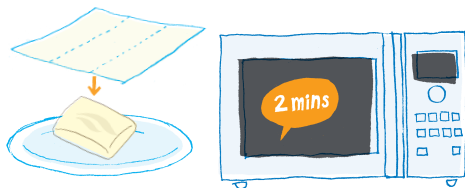

3. Watch the bar of soap as it begins to expand and erupt into puffy clouds. Be careful not to overcook it.
4. Allow the soap to cool for a minute. Touch it. Feel it. Look at it.

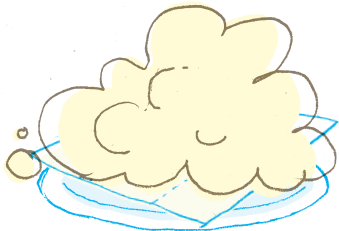

Materials

Ivory soap®
Paper towels
A microwave
(with adult supervision)
A plate

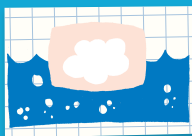

How does it work?

Ivory soap® floats because it has air pumped into it during manufacturing. When the air inside the soap heats up, the air expands and reacts with the water inside. The expanding gases push on the softened soap, creating foam. This effect is a demonstration of Charles' Law. Charles' Law states that as the temperature of a gas increases, so does its volume.

SCIENCE
CHALLENGE

21

COLOURED CARNATIONS

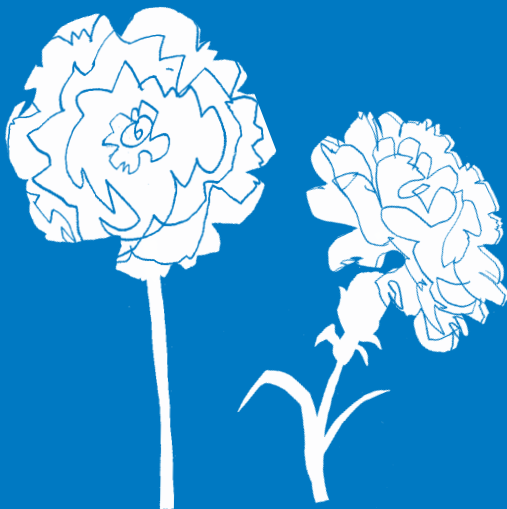

THE
JAMES
DYSON
FOUNDATION

COLOURED CARNATIONS

Designed by Adam,
Science teacher and former
Design engineer at Dyson

The brief

Create multi-coloured flowers.

The method

1. Use the scissors to cut the stem of the carnation in half lengthways.
2. Take two cups and fill them with water. Add a different coloured food dye to each cup.
3. Put the split stems of the carnation into the cups and leave overnight.
4. The next morning you should find that your flower has changed colour.
5. What do you notice about the petals?

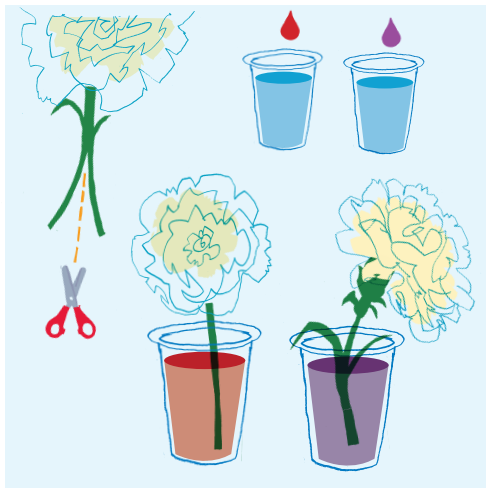

Materials

White carnations

Two colours of food dye

Plastic cups

Water

Scissors

(with adult supervision)



How does it work?

Plants need a transport system to move food, water and minerals around.

There are two things that combine to move water through plants – transpiration and cohesion.

Water evaporating from the leaves (transpiration) draws water up the stem of the plant to replace what is lost. This works in the same way as sucking on a straw. Water that evaporates from the leaves “pulls” (cohesion) other water behind it up to fill the space left by the evaporating water.

INVISIBLE INK



hello

INVISIBLE INK

SCIENCE
CHALLENGE

22

Designed by Jack,
Design engineer at Dyson

The brief

Write your own secret message in an invisible ink solution.

The method

1. Squeeze lemon juice into the bowl and add a few drops of water. Stir with the spoon.
2. Dip the paint brush into the juice mixture and write a message on the paper.
3. Allow the paper to dry completely. Your message should become invisible.
4. Hold the paper very close to the light bulb to heat up the message area (adult supervision required). Watch your message appear.

Materials

-
A lemon
-
A bowl
-
Water
-
A spoon
-
A paint brush
-
A lamp, or other light bulb



How does it work?

The lemon juice is an organic substance which reacts with oxygen in the surrounding air, oxidises and turns brown. By placing the paper right next to the lamp we speed up the oxidation process. The heat from the lamp causes the chemical bonds to break down.

Did you know?

Oxidation affects lots of different surfaces, from metal to living tissue. A freshly-cut apple that turns brown, a bicycle that becomes rusty or a copper penny that turns green. Not all oxidation is bad – but think about choosing the right materials when designing a product for a particular use.



ENGINEERING
CHALLENGE

01

GEODESIC DOMES



THE
JAMES
DYSON
FOUNDATION

GEODESIC DOMES

ENGINEERING CHALLENGE 01

Designed by Hannah,
Design engineer at Dyson

The brief

Using jelly sweets and cocktail sticks, make your own geodesic dome.

The method

Follow steps 1 – 6 in the diagram below.

Key for cocktail sticks: — 60mm — 54mm

Materials

Cocktail sticks: 35 at
60mm long and 30
cut down to 54mm long

Jelly sweets

Scissors

(with adult supervision)

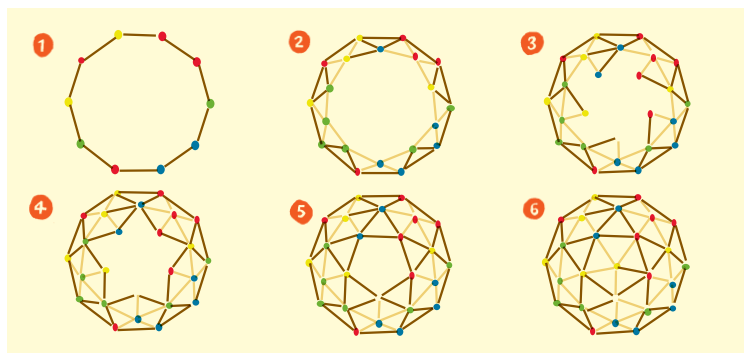

How does it work?

Geodesic domes are extremely rigid. Multiple interlocking triangles form incredibly strong structures.

To deform or buckle a triangle you have to compress or stretch the lengths of the sides, which is hard to do as they support each other.

Design icons

Richard Buckminster Fuller,
inventor of the geodesic dome.
He was inspired by beehives,
fishing nets and other 'networks'.

Today there are more than
300,000 geodesic domes
around the world.



ENGINEERING
CHALLENGE

02

MARBLE RUN



THE
JAMES
DYSON
FOUNDATION

MARBLE RUN

ENGINEERING CHALLENGE 02

Designed by Coco,
Design engineer at Dyson

The brief

Use a cardboard box and cardboard struts to create a marble run. The marble must run for 60 seconds.

The method

1. Use sticky tape to attach the cardboard struts to the cardboard box, creating a run for the marble.
2. Place the marble at the top of the run and time how long it takes for it to reach the bottom.
3. Keep improving your design until the marble takes exactly 60 seconds to reach the bottom.

Top tip

If you can't find cardboard struts, make your own by folding four inch wide strips of cardboard in half to create a V shape.

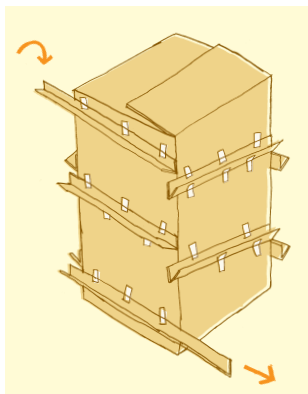
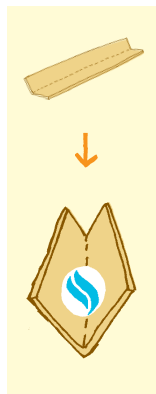

Materials

Large cardboard box

Cardboard struts

Sticky tape

Marbles

Scissors

(with adult supervision)

How does it work?

To help you to control the time your marble takes to run its course you'll need to consider a few factors:

Potential energy =
 $\text{mass} \times \text{gravity} \times \text{height}$

The heavier your marble and higher your slope, the more energy your marble will have.

Friction

The rougher or stickier the surface, the slower your marble will travel.

Angle of the slope

The less steep the angle of the slope, the longer the marble will take to reach the bottom.

ENGINEERING
CHALLENGE

03

SPAGHETTI BRIDGES



THE
JAMES
DYSON
FOUNDATION

SPAGHETTI BRIDGES

ENGINEERING CHALLENGE 03

Designed by Kristian,
Design engineer at Dyson

The brief

Construct a free standing bridge out of spaghetti, strong enough to support a 250g bag of sugar.

The method

Think about bracing strands together for strength. Some shapes are better at absorbing loads – triangles are particularly strong. Rubber bands make for good junctions.

Top tip

Be patient. Through trial and error, you'll become proficient at working with spaghetti.

Materials

Spaghetti
Small rubber bands
or bag ties
Sticky tape
250g bag of sugar

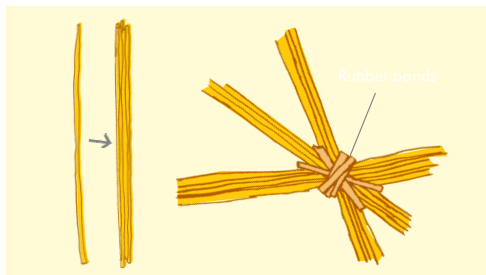

How does it work?

Bridges manage two important forces: compression and tension – pushing and pulling. Too much of either and they buckle or snap.

Design icons

Why not take inspiration from these iconic bridge designs?



Beam bridge



Truss bridge



Cable stayed bridge



Arch bridge



Suspension bridge



Cantilever bridge

STRONG AS A DRINKING STRAW



STRONG AS A DRINKING STRAW

ENGINEERING CHALLENGE 04

Designed by Phil,
Design engineer at Dyson

The brief

Use a drinking straw to pierce through a raw potato.

The method

1. Hold the straw by its sides, without covering the hole at the top and try quickly stabbing the potato.
2. Repeat the experiment with a new straw but this time place your thumb over the top, covering the hole.

Materials

Two stiff drinking straws

A firm, raw potato

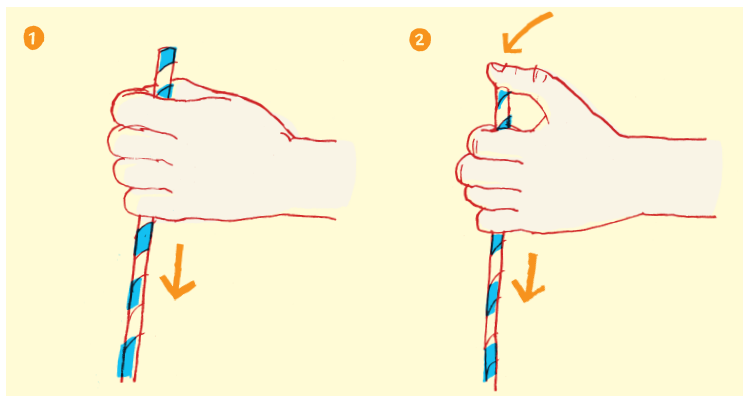

How does it work?

Covering the top of the straw with your thumb traps air inside, forcing it to compress as you stab the straw through the potato skin. This creates enough rigidity within the straw to pierce the potato.



ELECTRIC MOTOR

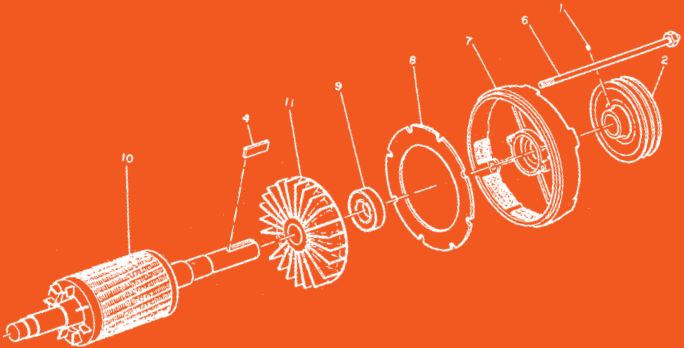

ELECTRIC MOTOR

ENGINEERING CHALLENGE 05

Designed by Mike,
Design engineer at Dyson

The brief

Build your own electric motor.

The method

1. Attach the magnet to the head of the screw.
2. Holding the battery in your hand, hang the pointy end of the screw from the positive terminal of the battery. Hold one end of the wire to the negative terminal of the battery.
3. With your other hand, touch the opposite end of the wire to the head of the screw and watch it spin.

Top tip

What happens if you swap the battery terminals?

Materials

.....
An AA battery

.....
A screw

.....
A small, round
neodymium magnet
(approx. 6mm
diameter)

.....
A wire

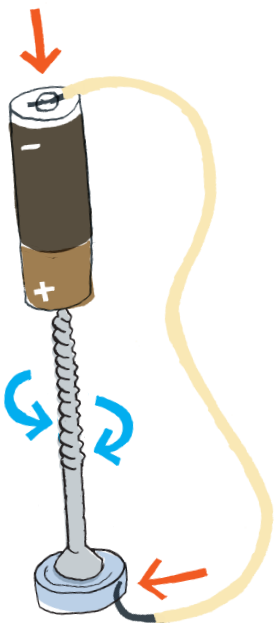

How does it work?

The electric current passing through the screw when the circuit is completed by the wire is subject to the Lorentz force. This force creates torque, which turns the screw.

Design icons



Michael Faraday built the first electric motor in 1821.

COTTON REEL TANK

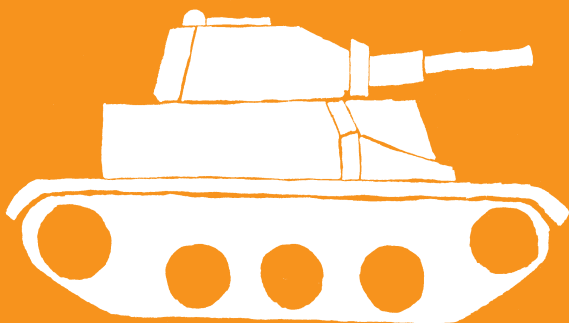

COTTON REEL TANK

Designed by Neil,
Electronics engineer at Dyson

The brief

Build a tank out of a cotton reel.

The method

1. Thread the rubber band through the cotton reel.
2. Break one matchstick in half. Tie one end of the rubber band around the half matchstick and secure it to the end of the cotton reel using sticky tape.
3. Cut 2cm and use a pencil to make a hole in the middle of it. Thread onto the other end of the rubber band. Place the other match through the loop of the band.
4. Wind up the match to create tension. Place it on the floor and let it go.

Materials

A cotton reel

A long white candle

A rubber band

Sticky tape

Two matchsticks,
with their heads removed

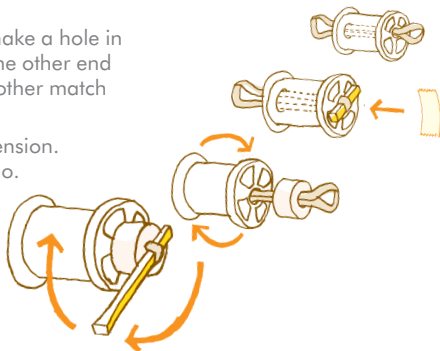

How does it work?

Winding up the rubber band creates potential energy. When the band is released this stored energy converts into kinetic energy, causing the tank to move.

Design icons



In a car, potential energy exists in the form of liquid gasoline. It is converted into kinetic energy as the fuel is ignited in the engine's combustion chamber.

ENGINEERING
CHALLENGE

07

CARDBOARD BOAT



THE
JAMES
DYSON
FOUNDATION

CARDBOARD BOAT

ENGINEERING CHALLENGE 07

Designed by Ben,
Design engineer at Dyson

The brief

Construct a boat to support up to 250g without sinking.

The method

1. Draw out the basic shape of your boat on the cardboard, and cut it out.
2. Create walls for your boat from more cardboard.
3. Stick the bottom of the boat and the walls together with tape or glue.
4. Back everything with wax paper or foil – be careful not to leave any gaps where the water can get in.
5. Place the 250g weight in the boat.
6. Set your boat afloat.

Top tip

Think about stability. Some shapes are more stable than others when a load is applied.

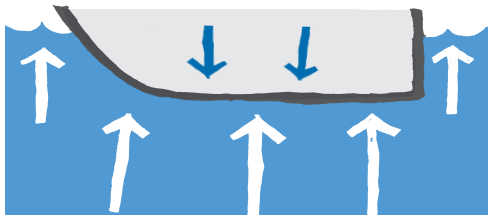

How does it work?

When a boat is placed in water, it displaces an amount of water equal to the boat's weight – as long as the object is less dense than the water, it will float.

Materials

- Cardboard
- Wax paper
- Tape or glue
- Rubber bands
- Foil
- Scissors
(with adult supervision)
- Craft knives
(with adult supervision)
- A 250g weight

Design icons



The SS Great Britain was the first iron steamer to cross the Atlantic. Designed by Isambard Kingdom Brunel in 1845, it was the first ship to combine an iron body with a screw propeller.

ENGINEERING
CHALLENGE

08

CARDBOARD CHAIR



THE
JAMES
DYSON
FOUNDATION

CARDBOARD CHAIR

Designed by Andy,
Design engineer at Dyson

The brief

Construct a chair that you can sit on using only cardboard. No glue, tape or other fixing materials allowed.

The method

1. Write down or sketch some ideas as to how you will construct the chair.
2. When you are planning, think about using cones, interlocking sheets, spirals, tubes – or even using strips of card like sewing thread.
3. Use the materials to create a chair made from cardboard.
4. If your first design doesn't work, evaluate what went wrong and try again.

Top tip

Think about structure.

Materials

Cardboard

Cutting equipment
(with adult supervision)

Rulers

Pencils



Examples of different structures:

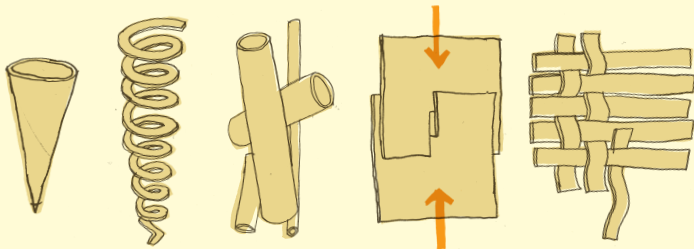

BOAT POWERED BY A CHEMICAL REACTION



BOAT POWERED BY A CHEMICAL REACTION

ENGINEERING CHALLENGE 09

Designed by Rob,
Engineering reliability
manager at Dyson

The brief

Build a boat powered by a chemical reaction.

The method

1. Tape the cork and ice lolly sticks together to form a triangle.
2. Tape the triangle to the middle of one side of the bottle.
3. Make a hole in the end of the bottle, at the opposite side to the triangle, so it will sit below the water.
4. Push the drinking straw through the hole so the end inside the bottle touches the inside wall.
5. Pour in vinegar and add bicarbonate of soda. Screw the bottle top back on tightly.
6. With a thumb covering the end of the drinking straw, shake the bottle.
7. Once the reaction starts, drop the boat in the water and watch it propel forward.

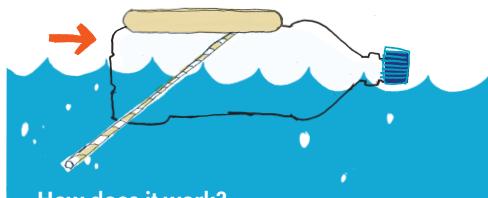

How does it work?

When the vinegar and bicarbonate of soda come into contact, a chemical reaction occurs and carbon dioxide is released. This causes pressure to build, gas to be forced down the straw and the boat to be propelled across the water.

Materials

Small plastic bottle
Sticky tape
A cork
Two ice lolly sticks
Scissors
(with adult supervision)
A drinking straw
Vinegar
Bicarbonate of soda
Somewhere to sail it
– such as a bath tub
or sink

Design icons



Rockets use a chemical reaction during lift off. Combining fuel and oxygen causes combustion and exhaust gases are released. These gases exit the engine nozzle at high speed and push the rocket skyward.

ENGINEERING
CHALLENGE

10

CARTESIAN DIVER

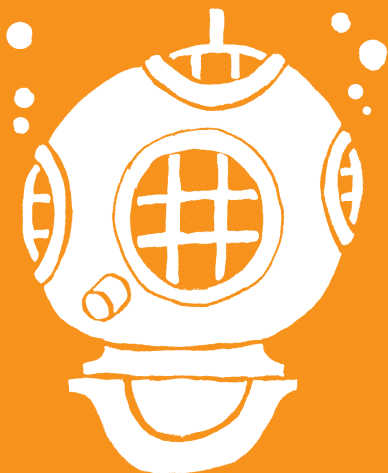

THE
JAMES
DYSON
FOUNDATION

CARTESIAN DIVER

Designed by Daryl,
Design engineer at Dyson

The brief

Build a Cartesian diver.

The method

1. Put a small ball of plasticine on the top of the straw to seal it.
2. Roll a sausage of plasticine and wrap it around the bottom of the straw, leaving the bottom open. This is your diver.
3. Now attempt to balance the diver so that it stays upright.
4. Place the diver vertically in the drinking glass. Add or remove weight from the base or top so that when you push it down, it just about bobs back up to the surface (and stays upright).
5. Once you are happy, place the completed diver in the two litre bottle filled to the top with water. Screw on the lid. Squeeze the bottle, and the diver will drop down to the bottom of the bottle. Release it and it floats back to the surface.

Materials

Drinking straw cut to 30mm in length

Plasticine

A two litre bottle

A drinking glass and water

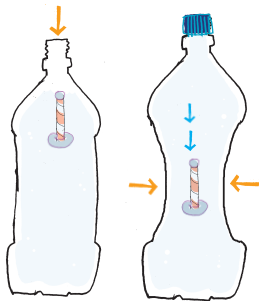

How does it work?

This is all about density. When the diver floats, there is a volume of air trapped inside, when the bottle is squeezed, the air is compressed but the water is not.

The volume of air trapped decreases, and the displaced water reduces. The diver loses buoyancy, and sinks. When the pressure on the bottle is released, the air expands, displaces the water and the diver floats.

Design icons

Submarines are surrounded by ballast tanks, which help control their buoyancy. When filled with water, the tanks increase the density of the submarine and it sinks. When the submarine needs to rise, the water in the ballast tanks is replaced with compressed air.

BALLOON CAR RACE



BALLOON CAR RACE

Designed by Caroline,
Engineer at Dyson

The brief

Make and race a balloon powered car.

The method

1. Using scissors, carefully cut the cup in half lengthways, to create the car body.
2. Using a pencil, poke two sets of holes through the length of the cup. One set near the top of the cup, and one set near the bottom. Poke another hole through the bottom of the cup.
3. Insert a straw through each set of holes. Then, slide the cotton reels or lid wheels on to each end of the straws.
4. Wrap a rubber band around the end of each straw; these will keep the wheels from sliding off.
5. Push the neck of the balloon through the hole in the bottom of the cup. The balloon should be lying inside the cup. Make sure the hole is big enough to let the air out.
6. Blow up the balloon, place on a hard surface and release.

Materials

A balloon
A paper cup
Two plastic drinking straws
Four cotton reels (or drink lids with holes in them)
Four small rubber bands
Scissors (with adult supervision)
A pencil

How does it work?

The balloon powered car is a good example of Newton's Third Law. If object A pushes on object B, object B pushes back on object A with the same amount of force. The force of the air leaving the balloon pushes the car forward.

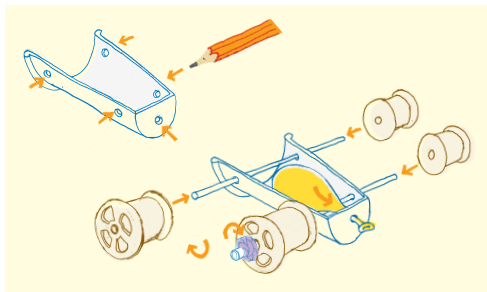

ENGINEERING
CHALLENGE

12

DESIGN AND BUILD A HELICOPTER



THE
JAMES
DYSON
FOUNDATION

DESIGN AND BUILD A HELICOPTER

Designed by Ahmed,
Design engineer at Dyson

The brief

Design and build a helicopter using only paper and paperclips.

The method

1. Take a piece of paper and make three cuts as shown in the illustration. Then fold the paper in on itself at the bottom half – use a paper clip to keep the sides together.
2. Fold the two halves of the remaining paper away from each other, to form the helicopter blades.
3. Stand carefully on a chair and drop your helicopter, making sure it stays upright as you let go!

Materials

A4 sheet of paper

Paper clips

Scissors

(with adult supervision)

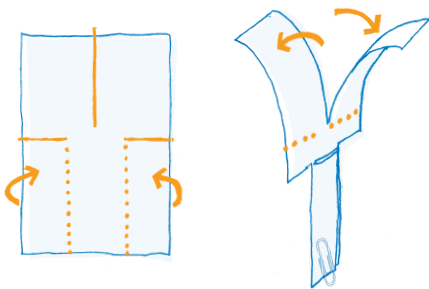

Design icons



Juan de la Cierva's Cierva C.8.

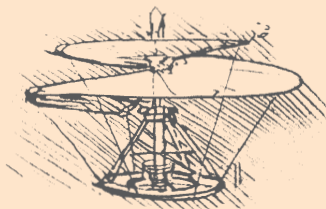

Leonardo da Vinci's Aerial Screw.

ENGINEERING
CHALLENGE

13

WATER CLOCK



THE
JAMES
DYSON
FOUNDATION

WATER CLOCK

Designed by Sam,
Teacher and Design
and Technology enthusiast
at Malmesbury Primary School

The brief

Create a water clock that times exactly one minute with 200ml of water.

The method

1. A simple water clock could consist of two plastic cups fixed one above the other with a hole in the top cup to allow water to pass from one to the other.
2. Additional cups, string, straws, plasticine, etc. can also be used to create more elaborate examples or to help slow the water if necessary.

Top tip

You will need to use a timer to observe and measure time accurately and make changes depending on your results. The size and position of the holes, the number of cups the water passes through, the angle of straws and flow rates will all affect your design.

Materials

Plastic cups
Straws
Plasticine
String
A timer
Wooden doweling or
similar to act as a stand
Scissors
(with adult supervision)
Tape
Drawing pins

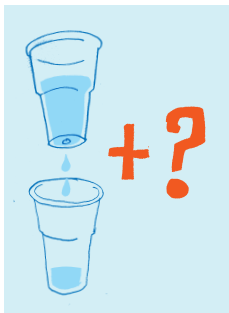

Design icons

Water clocks are among the most ancient of time pieces, with known examples from Egypt dating to the 16th Century BC. Examples with gears and feedback systems were developed during the Greek and Roman periods.



METAL ETCHING

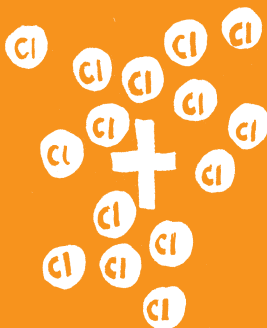

METAL ETCHING

Designed by Ed,
Design and Technology student
and JDF ambassador at
Malmesbury School

The brief

Etch a pattern into a sheet of metal using only things found in your home.

The method

1. Fill the bowl with 4cm of water.
2. Mix salt with the water until no more can be dissolved.
3. Draw a pattern using the permanent marker on one sheet of metal.
4. Connect one crocodile clip to the metal on which you have drawn the pattern and the other to the spare piece of blank metal.
5. Place both pieces of metal in the salty water. Make sure they're as far apart as possible – don't let them touch.
6. Connect the patterned metal to the positive terminal of the battery and the plain metal to the negative terminal. The water will begin to fizz.
7. Wait about 10 minutes, then disconnect the battery and remove the patterned metal.
8. Clean it with water and nail varnish remover to remove the permanent marker. You should see that the pattern you drew is now permanently etched into the surface of the metal.



Materials

- Table salt
- Paper clips
- Scissors
(with adult supervision)
- Two pieces of sheet metal – mild steel
- Copper or brass
- 9v battery
- Two crocodile clip cables
- Nail varnish remover
- A permanent marker

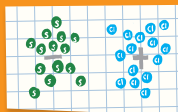

How does it work?

This process is called electrolysis. When you place electrodes into the salt water and apply electricity, chloride ions move towards the positive electrode and the sodium ions move towards the negative electrode. The reaction causes metal to be transferred from the positive side into the solution, etching away its surface.

ENGINEERING
CHALLENGE

15

JELLY AND OIL



THE
JAMES
DYSON
FOUNDATION

JELLY AND OIL

Designed by Sophie,
Design engineer at Dyson

The brief

Try to move jelly cubes from one place to another using chopsticks.

Materials

Jelly cubes

Chopsticks

Olive oil

The method

1. Try to move jelly cubes from one place to another using chopsticks.
2. Now cover the cubes in oil and try again.

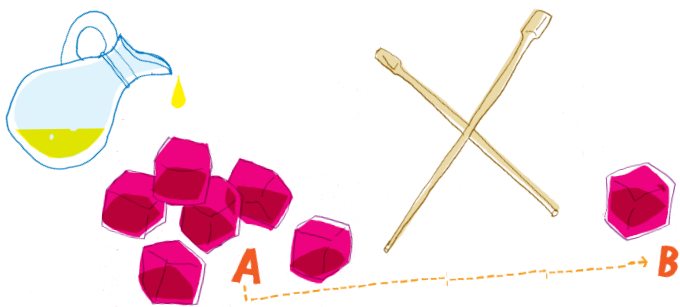

How does it work?

In order to grip an object, you need friction. When a lubricant like oil or water blocks the force of friction it becomes very difficult for two objects to make contact with each other.

Did you know?

Oil is used in engines to allow moving parts to slide past one another with ease – avoiding wear and tear.



ENGINEERING
CHALLENGE

16

BUILD A COMPASS



THE
JAMES
DYSON
FOUNDATION

BUILD A COMPASS

Designed by Adam,
Design engineer at Dyson

The brief

Build a compass.

The method

1. Fill the bowl with water.
2. Magnetise the needle by stroking it over the bar magnet about 50 times. Make sure the needle is orientated with the needle pointing to the north of the bar magnet on each stroke.
3. Drop the needle onto the surface of the water – from as close as you can – to let it rest on the surface tension.

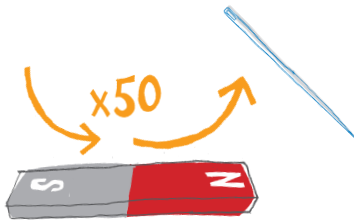

Materials

Water

Straight bar magnet

Steel needle

A bowl

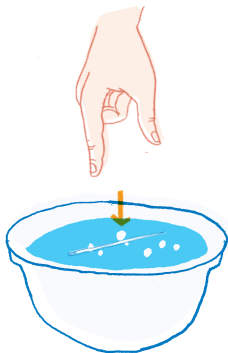

How does it work?

Once the needle is magnetised it naturally wants to align with the Earth's stronger magnetic field. This field, called the magnetosphere, is created by electrical currents that are generated by a churning molten iron core deep inside the planet.

The Earth acts as if it has a bar magnet running through it with the magnet's south pole located near the planet's geographic north. Since opposites attract, the north pole of a magnetised needle is attracted to it.

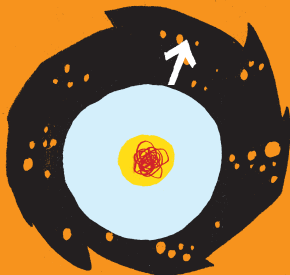

A TOUGH NUT TO CRACK



A TOUGH NUT TO CRACK

Designed by Sioned,
Design engineer at Dyson

The brief

Using brazil nuts and a nut cracker, crack open the shell without damaging the nut.

Materials

Brazil nuts in their shell

A nut cracker

The method

1. Cracking the nut across the centre with one flat side aligned with the nut cracker face will transfer all the force directly through into the nut. Most of the time, this will cause the nut to shatter. The cross section of a brazil nut is roughly an equilateral triangle.
2. Cracking the nut end to end is nearly impossible.
3. Instead, apply the force across one of the sides. The side should buckle breaking the shell but not the nut.

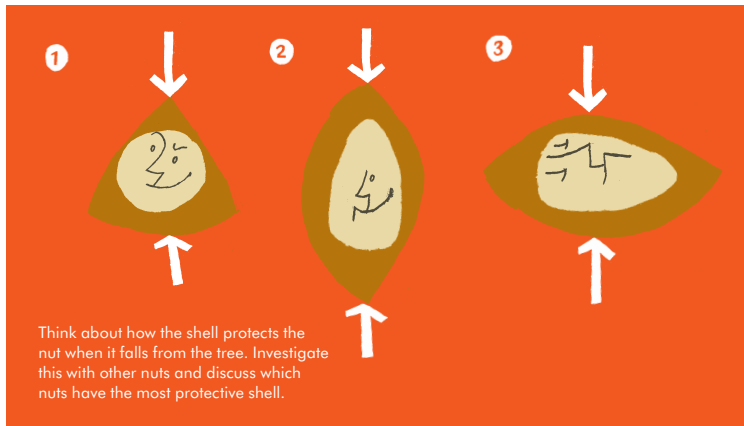

BURNING CUSTARD



BURNING CUSTARD

Designed by Hannah,
Design engineer at Dyson

The brief

Use custard to find out how the surface area of fuel affects how it burns.

The method

1. Connect the hosepipe to the base of the funnel.
2. Light the Bunsen burner and set it to full (the blue flame).
3. Put a small amount of the custard powder into the top of the funnel.
4. Wearing goggles, and staying clear of the flame, hold the funnel next to the Bunsen burner with the opening facing the flame.
5. Blow hard into the end of the hosepipe.

Materials

Custard powder

A funnel

1m length of hosepipe

Bunsen burner
(with adult supervision)

Goggles

This activity must be done in a science lab or large open space, with adult supervision.

How does it work?

Custard powder burns rapidly because it has a high total surface area to volume ratio, which allows oxygen in the air to come into contact with the fuel easily. When you have a large lump of wood, the oxygen can only touch the outside and so it burns from the outside in. If you turned that lump of wood into sawdust, the surface area would be greatly increased. This increase in surface area allows the oxygen to reach more places at once, so the fuel burns more quickly.



HOMEMADE WATER BOMB



HOMEMADE WATER BOMB

Designed by Louis,
Design engineer at Dyson

The brief

Make your own water bomb out of paper.

The method

1. Take a square piece of paper, fold it in half diagonally to create a crease and unfold. Repeat in the opposite direction so you have an 'x' shape.
2. Flip the paper over and fold in half top to bottom.
3. Flip the paper over again and press down in the middle, while folding in the flaps on the side. You should get a triangle.
4. Take the flaps on the front side and fold them up to the middle.
5. Fold the side corners to the middle line. This should create little pockets.
6. Take the flaps above the pockets and push them in to the pockets.
7. Repeat steps 4 – 6 on the other side.
8. Blow in the little hole in the bottom to inflate.
9. Use the pipette to fill your water bomb.

Materials

Square piece of paper

Water and a pipette

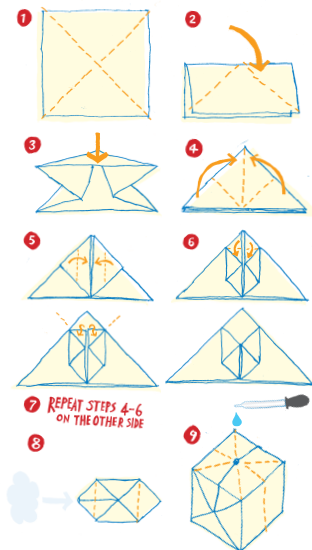

Design icons

Christchurch Cathedral in New Zealand is made from 98 giant cardboard tubes and designed to last for up to 50 years. The tubes are coated with three layers of waterproof polyurethane.

The cathedral was designed by Shigeru Ban, a Japanese architect who has been building with cardboard since 1986. The new cathedral is earthquake-proof, fireproof and won't get soggy in the rain.

How does it work?

Folding paper makes it more rigid.

ENGINEERING
CHALLENGE

20

POTATO POWER

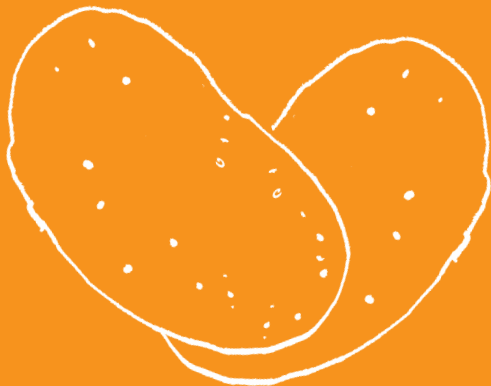

THE
JAMES
DYSON
FOUNDATION

POTATO POWER

ENGINEERING CHALLENGE 20

Designed by Sarah,
Design engineer at Dyson

The brief

Make your own potato clock.

The method

1. Label one potato 'A' and the other 'B'.
2. Place one galvanized nail in each potato.
3. Place one copper wire piece into each potato (placing it as far away from the galvanized nail as you can).
4. Open the battery compartment of the clock and remove the battery.
5. Connect the first jump wire from the copper wire of potato A to the positive terminal of the clock.
6. Connect the second jump wire from the galvanized nail of potato B to the negative terminal of the clock.
7. Connect the third jump wire from the galvanized nail of potato A to the copper wire of potato B.
8. Check the clock. It should now be running on potato power.

Materials

Two large, clean potatoes
Two galvanized zinc nails
Two copper wires
Three jump wires (with crocodile clips on each end)
A battery operated LCD clock

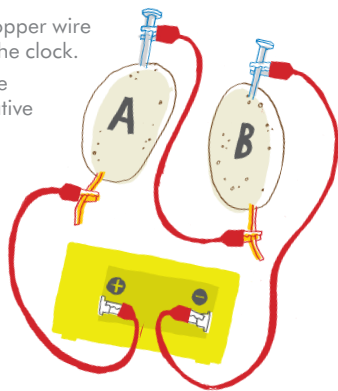

How does it work?

Each potato works as a galvanic cell, releasing electrical energy through chemical reactions. The potato juice acts as the electrolyte, in which charged atoms and molecules, called ions, dissolve and can flow over time. Wiring the potato cells end-to-end makes a series circuit, pulling the stream of electrons through the clock.

MAKE A PERISCOPE



MAKE A PERISCOPE

ENGINEERING CHALLENGE 21

Designed by Guy,
Design engineer at Dyson

The brief

Design and build your own periscope to see around corners.

The method

1. Remove the box lid.
2. Place one mirror on the side and near the bottom of the shoebox and trace around it. Place the second mirror at the opposite end of the shoe box and trace around that too.
3. Cut out the traced sections to make a door flap. Slant the doors at 45 degree angles.
4. Tape the mirrors onto the slanted doors.
5. Adjust the mirrors. Keep moving them into place until you can see out of the top hole when you look in through the bottom hole.
6. Seal the mirrors into place using PVA glue.
7. Glue the shoebox lid back on.

Materials

- Shoebox
- Two small mirrors
- A pencil
- Scissors
(with adult supervision)
- Tape
- PVA glue

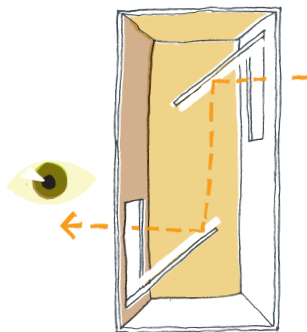

How does it work?

Light reflects away from a mirror at the same angle that it hits the mirror. In your periscope, light hits the top mirror at a 45 degree angle and reflects away at the same angle, which bounces it down to the bottom mirror. The reflected light hits the second mirror at a 45 degree angle and reflects away at the same angle, into your eye.



ATTRACTIVE NAILS

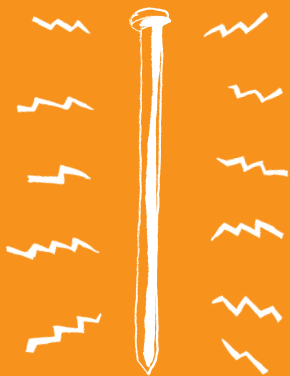

ATTRACTIVE NAILS

Designed by Latif,
Design engineer at Dyson

The brief

Make your own electromagnet.

The method

1. Wrap the insulated copper wire around the iron nail, leaving 20cm of loose wire at either end.
2. Remove 3cm of insulation from the ends of the copper wire and attach to either end of the battery with tape.
3. You now have an electromagnet. The nail should attract the iron filings and paper clips.

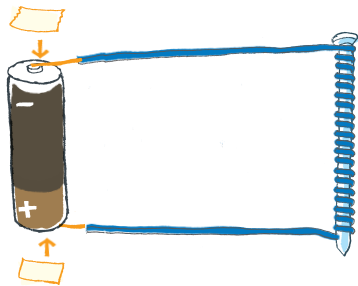

Materials

Insulated copper wire –
thin insulation is best

Tape

A battery

An iron nail

Iron filings
or paper clips

Did you know?

Many objects around you
contain electromagnets.



They are found in
electric motors and
loudspeakers. Very
large and powerful
electromagnets are
used as lifting magnets
in scrap yards to pick
up then drop old cars
and other scrap iron
and steel.

How does it work?

Most magnets cannot be turned off. When electric current runs through a wire it creates a magnetic field – and that's why electromagnets can be turned on and off.

Running current through a wire produces a weak magnetic field – usually too weak to give us visible results. By coiling the wire closely, you amplify the magnetic influence which gives visible results.